



USER GUIDE

Argo-LM

v2.0

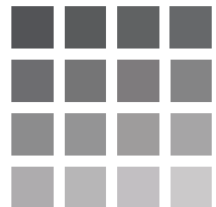

Table of contents

1. Introduction	1
2. First use	2
2.1. Parcel verification	2
2.2. Quick start procedure	2
3. General handling and care	4
3.1. Handling and storage	4
3.2. Cleaning.....	4
3.3. Operating environment.....	4
4. Technical specifications	6
4.1. Physical and dimensional specifications	6
4.2. Glass refractive index	7
4.3. Patterns overview	8
4.4. Fluorescence spectral features	10
4.5. Suggested analyses	14
5. Description of the patterns	15
5.1. Field of rings (PAT-AG03-EM3-B3).....	15
5.2. 4x4 intensity gradation (PAT-AG03-EM3-C3).....	16
5.3. 3D crossing stairs (PAT-AG03-EM3-I9)	17
5.4. Repositioning crosses (PAT-AG03-EM3-H3).....	18
5.5. Word ARGOLIGHT (PAT-AG03-EM3-J3)	18
5.6. Coordinates of each pattern	19

1. Introduction

The Argo-LM (Low Magnification) is specifically designed to assess and monitor the performance of fluorescence imaging systems, such as wide-field, confocal laser scanning or confocal spinning disk microscopes, with low magnifications. The Argo-LM is compatible with system magnifications ranging from 5 up to 20x. It contains the third generation of Argoglass®.

The Argo-LM is not compatible with imaging modalities based on total internal reflection (TIRF), fluorophore localization (PALM, STORM, DNA-PAINT) and stimulated emission by depletion (STED).

This product is composed of:

- An aluminum slide that includes one piece of Argoglass® with embedded fluorescent patterns inside.
- A dedicated software, Daybook, to generate, track and export quality control data.

The piece of Argoglass® consists of a special glass substrate with different fluorescent patterns embedded inside. The Argo-LM is designed to quality-control many aspects of a low magnification fluorescence imaging system, such as: field uniformity, field distortion, lateral co-registration accuracy, intensity response, stage drift during Z-stacking, etc.

The Daybook software has two modules:

- The “Analysis” module, named “Daybook Analysis”: it allows to analyze and extract data (maps, graphics and metrics) from images of the patterns, in order to measure significant metrics of low magnification fluorescence imaging system.
- The “Data Manager” module, named “Daybook Data Manager”: it allows to visualize the data generated by the “Analysis” module, monitor the results, and manage the quality control reports.

The best of Argolight technology, adapted into a microscope slide format, combined with the Daybook software, opens the path to easy, yet reliable and complete, quality control of low magnification fluorescence imaging systems.

2. First use

2.1. Parcel verification

Inside the package, you will find:

- 1 Argo-LM.
- 1 storage box.
- 1 user guide documentation.
- 1 certificate of inspection.

Before starting, check that all these items are present and check if the Argo-LM has visible damages. If any damage is observed, please contact Argolight within one week (7 days) after delivery.

2.2. Quick start procedure

In order to quickly find and capture images of fluorescent patterns, we advise to follow the following steps:

- In your fluorescence imaging system, select a low magnification microscope objective, typically a 10× or 20×.
- Illuminate the glass with UV-blue light (preferably at a wavelength between 350 nm and 500 nm).
- Coarsely align the center of the field of view with the center of the glass, using the XY translation stages.
- Adjust the focus into the glass until clearly observing the fluorescent patterns through the eyepieces or camera(s).
- Move the slide to observe the pattern(s) of interest.
- Switch to your working microscope objective.
- Re-adjust, if necessary, the position of the pattern(s) and the focus in the glass. Once you are perfectly in focus and the pattern is centered with respect to the field of view, you can set to zero the X, Y and Z positions in the acquisition software, so that it will be easier to come back later to the pattern position.
- Start your imaging session.
- Save the image(s) of your pattern(s) of interest from your usual acquisition software.
- Run Daybook Analysis to get meaningful results.

To know how to image your pattern(s) of interest properly, please refer to our documentation, available within Daybook Analysis, or online on our website (www.argolight.com).

3. General handling and care

3.1. Handling and storage

In order to make the Argo-LM last for many years, we recommend that you observe the following handling and storage instructions:

- The third generation of Argoglass® is compatible with any type of immersion medium (oil, water, glycerol and air). In the case of a water immersion, continuous exposure higher than 20 minutes in a row should be avoided. When longer continuous exposures are required, use oils with the same refractive index as water as an immersion liquid.
- Do not illuminate with focused ultrashort pulsed lasers, like those used in multiphoton microscopy.
- Do not illuminate with irradiances (peak or average) larger than 50 GW.cm⁻².
- Do not drop out.
- Do not scratch the glass surfaces.
- Do not push towards an objective.
- Do not expose to extreme temperature and humidity conditions.
- Store in its suitcase (after having removed entirely the immersion liquid) at ambient temperature (10 – 40 °C) and normal relative humidity (20 – 70 % RH). Avoid ultraviolet irradiation.

3.2. Cleaning

To clean the glass surfaces, we recommend that you observe the following cleaning instructions:

- Remove dust using clean compressed air.
- Use lens tissue moistened with ethanol or isopropanol (alcohol degree higher than 90° for both), as one would do for any regular optical component.

Wearing gloves is advised. Do not use acetone.

3.3. Operating environment

The Argo-LM has been designed to be used at room temperature (10 – 40 °C) and under normal relative humidity (20 – 70 % RH). Both the glass and the aluminum slide composing the Argo-LM have a low thermal expansion

coefficient, so that temperature variations will not significantly affect the imaging of the patterns.

4. Technical specifications

4.1. Physical and dimensional specifications

The aluminum slide has the same format and dimensions as a standard microscope slide (75 mm × 25 mm), except for the thickness which is 1.5 mm (to satisfy the required rigidity for this kind of tool), as shown in Figure 1. The weight of the Argo-LM is approximately 8 g.

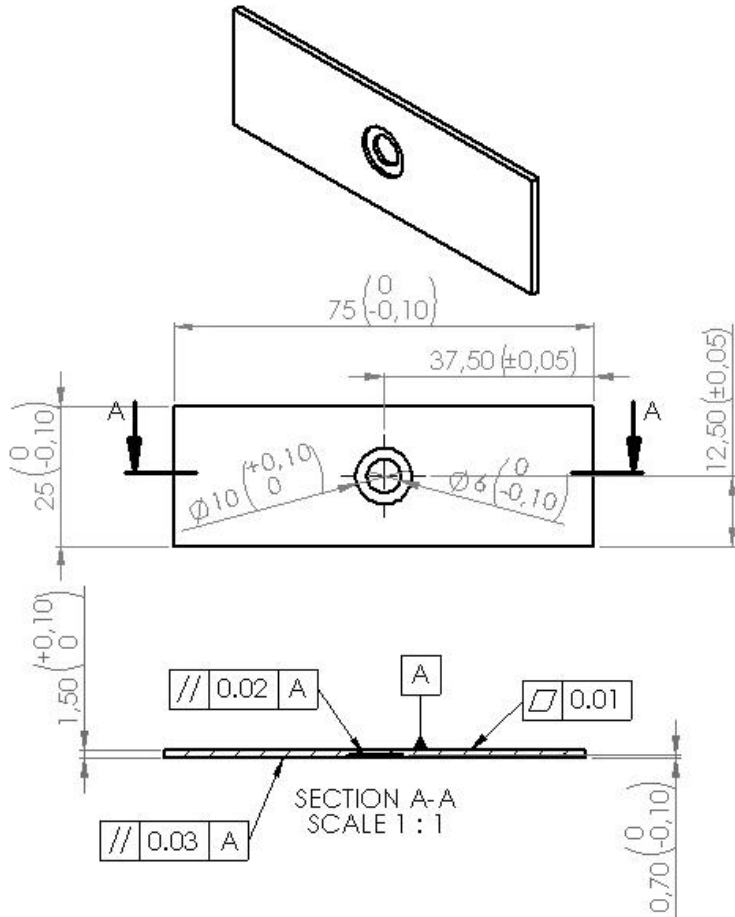

Figure 1: Scheme of the aluminum slide with dimensional specifications. All dimensions are in mm. General tolerances are ± 0.1 mm.

4.2. Glass refractive index

The slide contains one piece of Argoglass®, which is a special glass substrate produced at the Argolight facility to ensure homogeneity and purity.

The dispersion of the glass refractive index is shown in Figure 2. The measurement uncertainty is ± 0.001 . The Argoglass® features the same refractive index as microscope coverslips, defined in the ISO 8255-1:2017 standard.

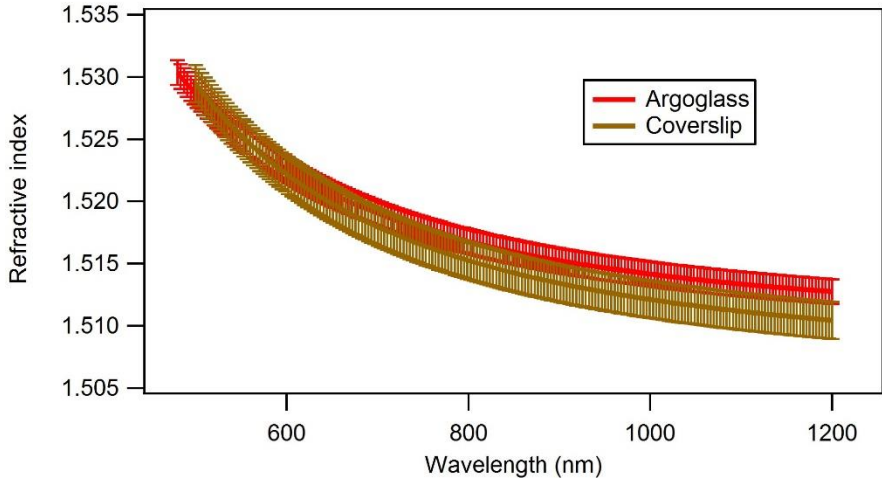

Figure 2: Dispersion of the refractive index of the Argoglass®, compared to the one of microscope coverslips.

The Sellmeier equation for the glass refractive index dispersion is (λ in nm):

$$n^2(\lambda) = A + \frac{B\lambda^2}{\lambda^2 - C} + \frac{D\lambda^2}{\lambda^2 - E}, \text{ which coefficients are provided in Table 1.}$$

Sellmeier coefficient	A	B	C	D	E
Value	0.699	0.697	136.960 nm ²	0.883	15269.000 nm ²

Table 1: Sellmeier coefficients for the refractive index dispersion of the Argoglass®.

4.3. Patterns overview

The fluorescent patterns, depicted in Figure 3, are positioned $(170 \pm 5) \mu\text{m}$ below the top surface of the Argoglass[®], whose optical flatness is typically $0.065 \mu\text{m}$, on a plane whose parallelism with respect to the bottom surface of the aluminum slide is less than or equal to 5 mrad .

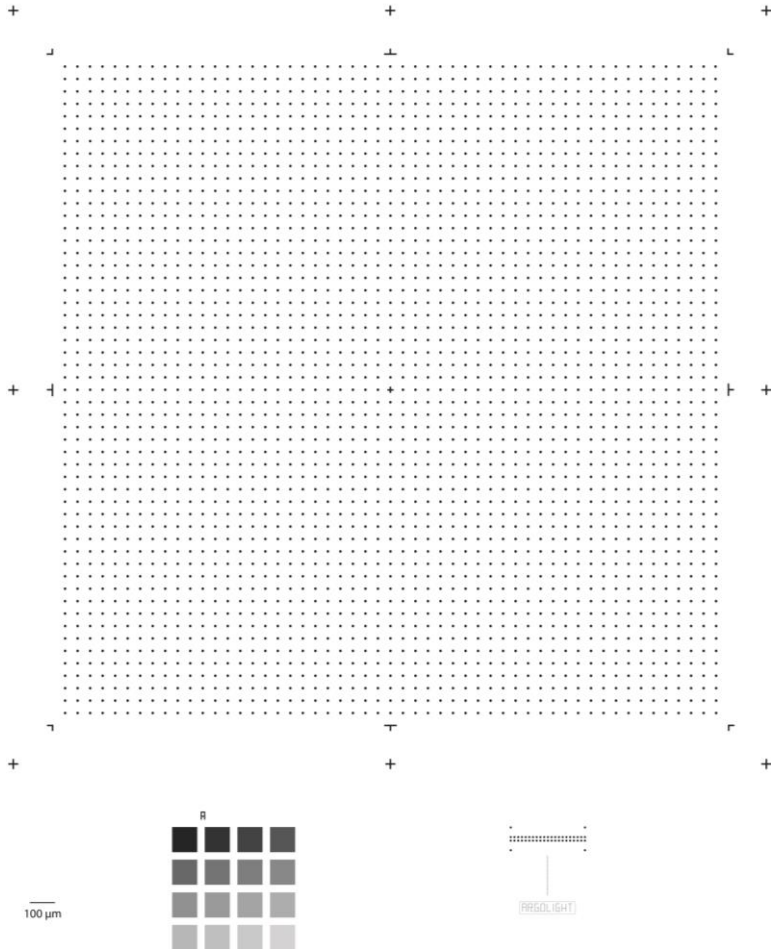

Figure 3: Schematics of the patterns inside the piece of glass of the slide. All dimensions are in μm .

These features emulate the presence of a #1.5H microscope coverslip, having a thickness of $(170 \pm 5) \mu\text{m}$ and a refractive index of (1.5255 ± 0.0015) at 546.1 nm.

The constituents within each individual pattern are positioned with a maximum relative error of $\pm 0.11 \mu\text{m}$ in XY and $\pm 0.15 \mu\text{m}$ in Z.

4.4. Fluorescence spectral features

The spectral features (excitation spectrum, emission spectrum and lifetime) of the patterns depend on the excitation and emission wavelengths, on the spatial scale at which they are measured, and on the illumination power density and duration.

Given the large range of possible irradiation conditions, Argolight only provides typical spectral features averaged on a scale of several micrometers, which are only valid for given excitation/emission conditions. Typical fluorescence spectral features are shown below.

- **Excitation**

The excitation ranges from 250 up to 650 nm. The excitation efficiency is maximum at around 340 nm and drops towards the red wavelengths. A typical absorption spectrum is shown in Figure 4.

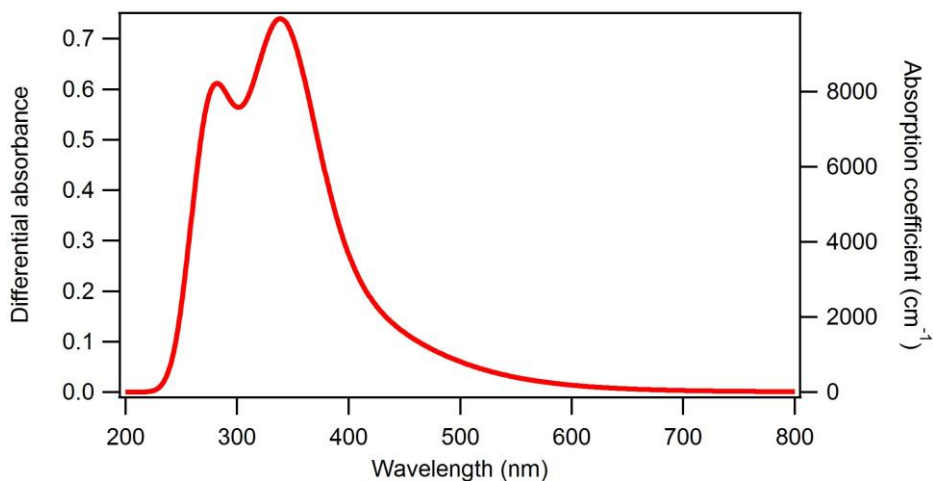

Figure 4: Typical absorbance/absorption spectrum of the patterns.

- **Emission**

The emission is a continuum starting from slightly above the excitation wavelength up to 800 nm. Typical emission spectra are shown in Figure 5 for UV-blue excitation wavelengths and in Figure 6 for visible excitation wavelengths.

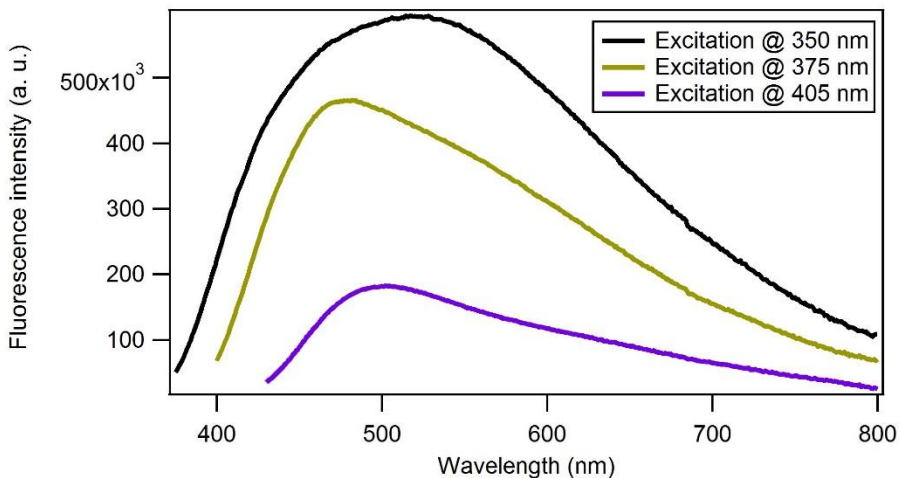

Figure 5: Typical emission spectra of the patterns for excitation wavelengths at 350 nm, 375 nm and 405 nm.

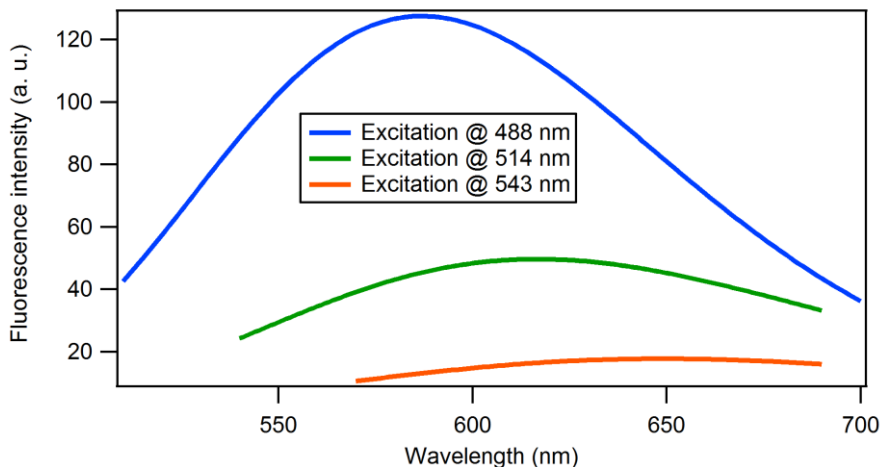

Figure 6: Typical emission spectra of the patterns for excitation wavelengths at 488 nm, 514 nm and 543 nm.

- **Lifetime**

Using FLIM (Fluorescence Lifetime Imaging Microscopy), two main decay components of (0.29 ± 0.05) ns and (2.52 ± 0.50) ns have been measured.

These values are provided for information and are not guaranteed. A typical fluorescence decay is shown in Figure 7.

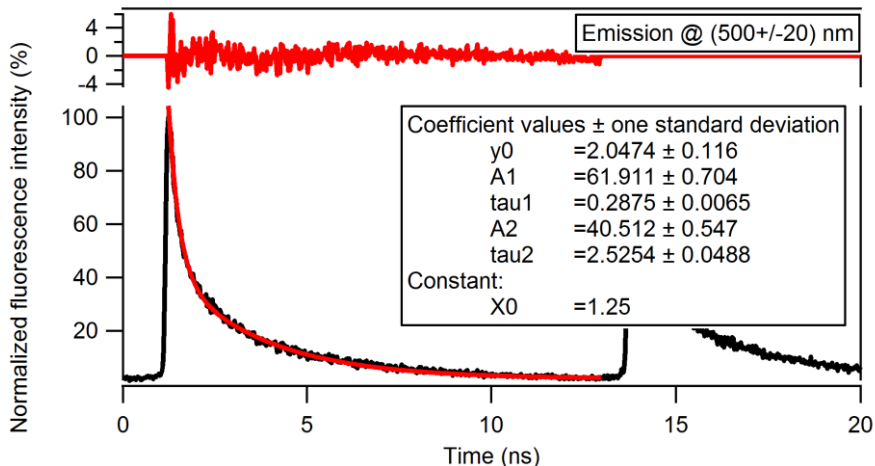

Figure 7: Typical fluorescence decay of the patterns for $\lambda_{\text{exc}} = 400 \text{ nm}$, $\Delta\lambda_{\text{em}} = (500 \pm 20) \text{ nm}$, $10\times/0.25$ objective.

- **Photo-stability**

The intensity of the patterns may decrease. However, this decrease is transient. The fluorescence intensity recovers to its initial value after some time. The recovery time, *i.e.* the time it takes to the fluorescence intensity to get back to its initial value, depends on the irradiation conditions (power density, illumination duration, excitation and emission wavelengths, zoom, etc.). The recovery time can be from seconds to months, with typical values in the minutes range. A typical fluorescence intensity recovery signal is shown in Figure 8.

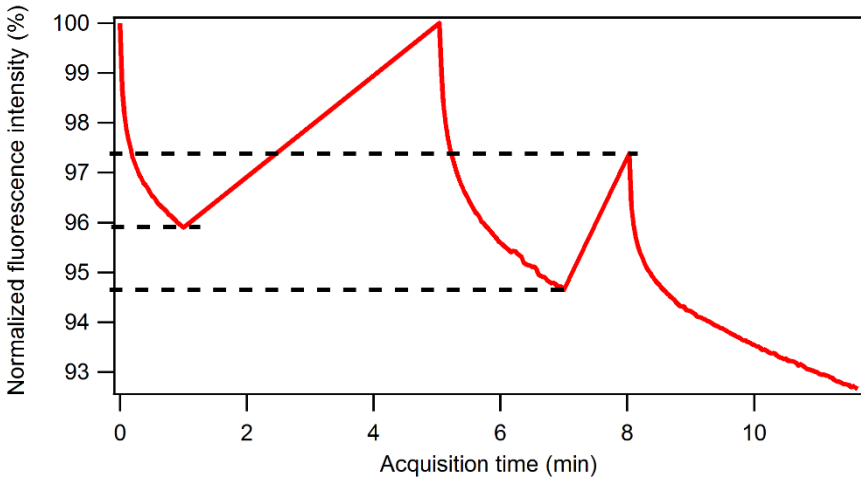

Figure 8: Typical fluorescence intensity recovery signal of the patterns. The power density was about 10 W.cm^{-2} , the excitation wavelength was $(470 \pm 20) \text{ nm}$ and the collection window was $(525 \pm 25) \text{ nm}$. After one minute of acquisition and four minutes of waiting time, the fluorescence fully recovers for these irradiation conditions. When the waiting time is not sufficient, the fluorescence intensity does not restart at its original level.



Proceed with caution!

The field or rings (section 5.1) and the 4x4 intensity gradation (section 5.2) are patterns for which fluorescence intensity is important. They must therefore be imaged with a lot of care:

- First, move to a pattern for which intensity is not important, such as a cross or the word ARGOLIGHT.
- Second, set all the acquisition parameters (illumination power, sensor gain, exposure time, etc.) for one of these patterns.
- Third, move to the pattern of interest (field of rings or 4x4 intensity gradation) and image it in one shot.

Do not image one of these patterns using a tiles acquisition mode.

By following this procedure, the transient fluorescence decay has barely the time to occur, making the recovery time much faster. This procedure allows a more frequent imaging.

4.5. Suggested analyses

Table 2 presents the analyses that can be performed with Daybook Analysis from images of the patterns in the Argo-LM. Note that this table is only valid for the Argo-LM, at the date of issue of this document. To know the up-to-date correspondence between the patterns and analyses, please refer to the “Start guide”, available directly under the “Help” menu of Daybook Analysis.

Pattern name	Associated analysis
Field of rings	Field uniformity Field distortion Lateral co-registration accuracy Line spread function Ring spread function
4x4 intensity gradation	Intensity response
3D crossing stairs	Stage drift during Z-stacking
Repositioning crosses	Stage repositioning repeatability Stage drift during timelapse
Word ARGOLIGHT	Spectral response

Table 2: Pattern and analysis correspondence in Daybook Analysis.

5. Description of the patterns

To know more about the functions and applications of each pattern, you can consult the “Applications guide”, available on the Argolight website: www.argolight.com/files/Argolight-solutions_Applications-guide.pdf

Documentations describing how to acquire images of these patterns and how to analyze them are available directly under the “Help” menu of Daybook Analysis.

5.1. Field of rings (PAT-AG03-EM3-B3)

This pattern, depicted in Figure 9, consists of a matrix of 53×53 rings, separated by 50 μm, on a total field of 2600 μm × 2600 μm. The field of rings is surrounded by eight landmarks and exhibits a 25 μm long cross in its center.

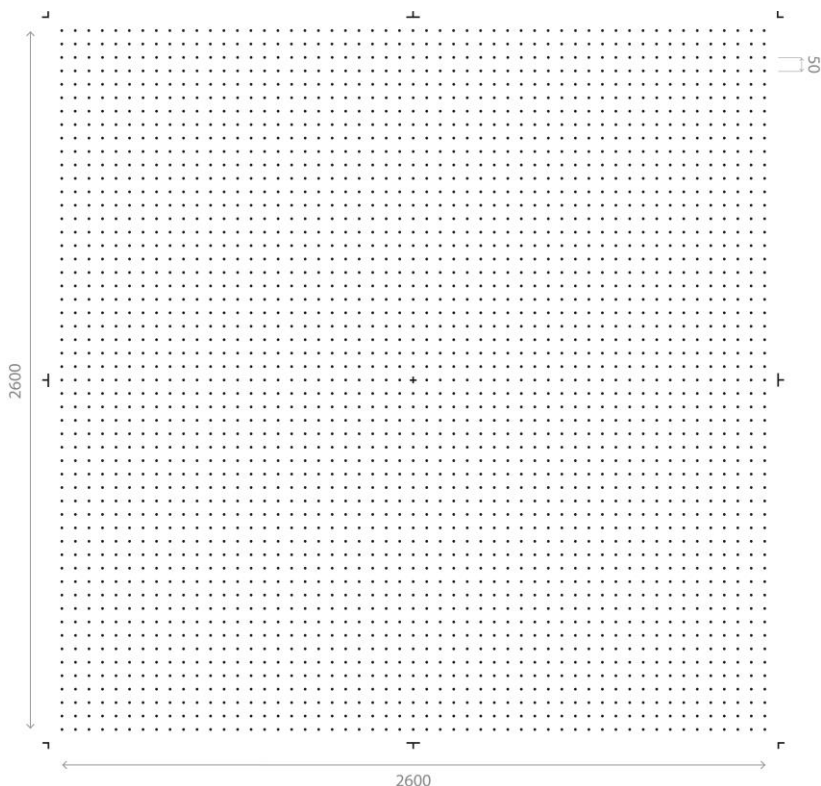

Figure 9: Schematics of the field of rings. All dimensions are in μm.

The typical transverse diameter (in the XY plane) of those rings is about $(1.8 \pm 0.3) \mu\text{m}$.

The typical axial length (in the Z direction) of those rings is about $(12.0 \pm 3.0) \mu\text{m}$ FWHM (Full Width at Half Maximum).

5.2. 4x4 intensity gradation (PAT-AG03-EM3-C3)

This pattern, depicted in Figure 10, consists of two layers of sixteen $100 \mu\text{m}$ -wide squares, on top of each other, having different fluorescence intensity levels following a linear evolution, organized in a 4x4 matrix.

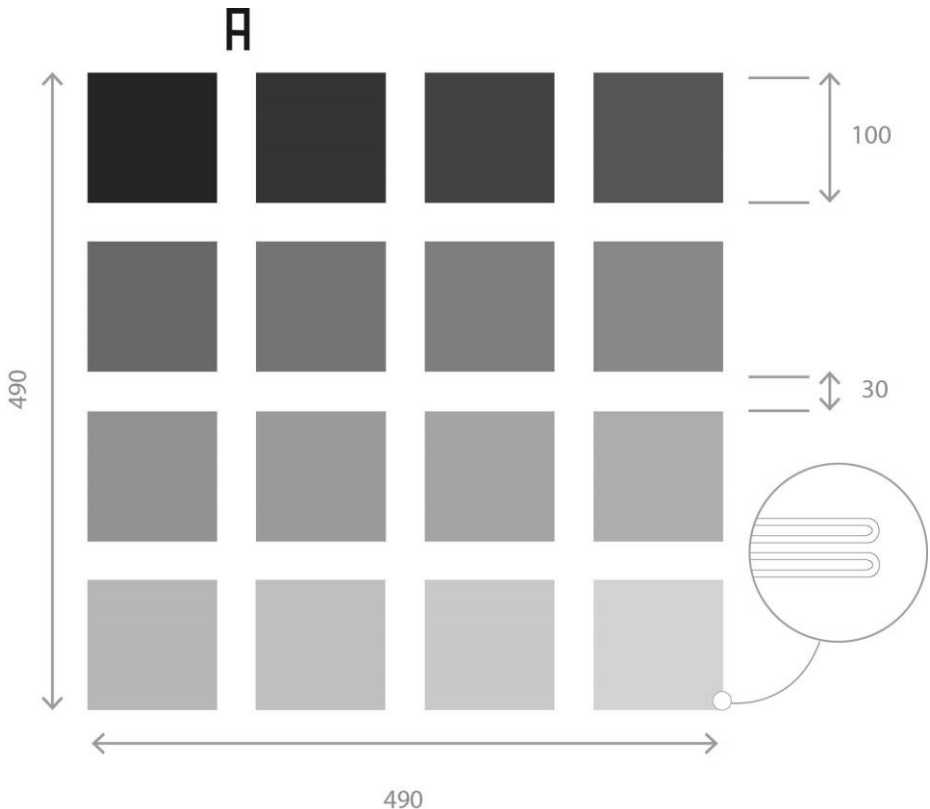

Figure 10: Schematics of the 4x4 intensity gradation. All dimensions are in μm .

5.3. 3D crossing stairs (PAT-AG03-EM3-19)

This pattern, depicted in the Figure 11, consists of twice 21 empty cylinders embedded at different depths, like two crossing stairs, with a step of $2.5\ \mu\text{m}$ and surrounded by four pillars.

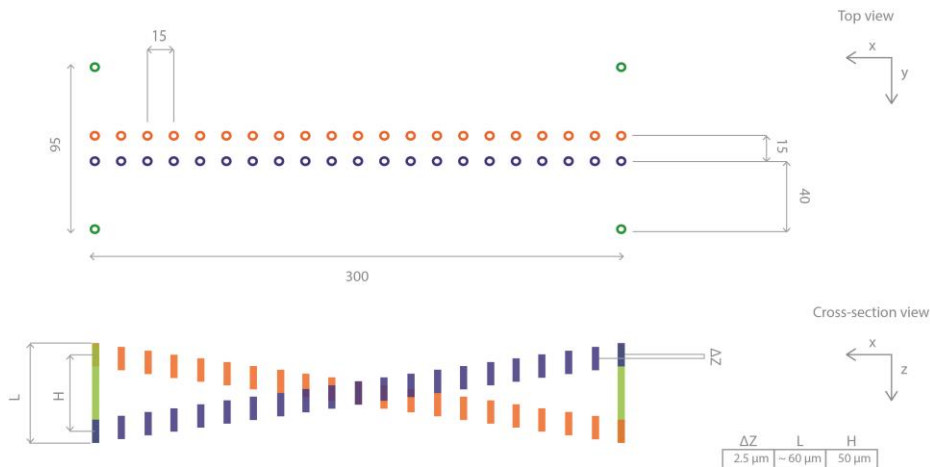

Figure 11: Schematics of the 3D crossing stairs. All dimensions are in μm .



Warning!

Depending on the objective used to image (Z-stacking) the 3D crossing stairs, the measured axial distances may be distorted, and shall therefore be corrected to be compared to the specified axial distances:

- For dry objectives, designed for use with a #1.5H coverslip, there is no correction factor to apply to the measured axial distances.
- For immersion objectives, designed for use with a #1.5H coverslip, the measured axial distances shall be divided by the refractive index of the immersion medium (for example: water \rightarrow 1.333, glycerol \rightarrow 1.475, regular oil \rightarrow 1.518).

The warning applies to the Argo-LM only. The correction factor may change from one Argolight product to another.

5.4. Repositioning crosses (PAT-AG03-EM3-H3)

The repositioning crosses, depicted in Figure 12, are 40 μm long and are positioned 1500 μm from one to another in the X direction, the Y direction, or both.

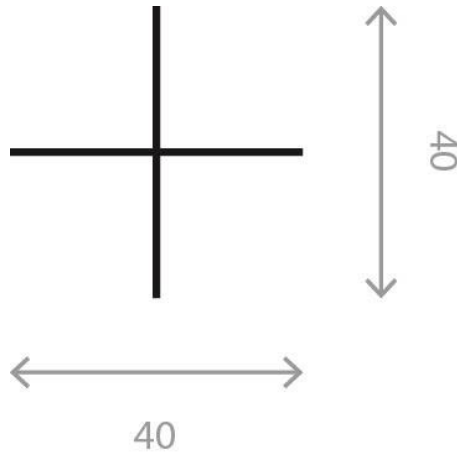

Figure 12: Schematics of one of the repositioning crosses. All dimensions are in μm .

5.5. Word ARGOLIGHT (PAT-AG03-EM3-J3)

This pattern, depicted in Figure 13, consists of the letters forming the company name “Argolight”, and surrounded by a 220 μm \times 50 μm frame.



Figure 13: Schematics of the word ARGOLIGHT. All dimensions are in μm .

5.6. Coordinates of each pattern

Table 3 presents the XY coordinates, relative to the central cross of the field of rings, of the center of each pattern, in order to help for the automation of the image acquisition.

Pattern name	Relative coordinates (X ; Y) in μm
Center of the field of rings	(0 ; 0)
4x4 intensity gradation	(-625 ; -1995)
3D crossing stairs	(625 ; -1772.5)
Word ARGOLIGHT	(625 ; -2075)

Table 3: XY coordinates of the center of each pattern relative to the central cross of the field of rings.

Date of issue: 01/10/2021 (1st October 2021)

User guide version: v1.1

Product name and version: Argo-LM v2.0

Copyright notice

Copyright 2021 by Argolight SA. All rights reserved. No part of this book may be used or reproduced in any form or stored in a database or retrieval system. Making copies of any part of this book for any purpose other than your own personal use is a violation of European copyright laws.

Contact information

Argolight SA
Cité de la Photonique, Bdg. Elnath
11 avenue de Canteranne
33600 Pessac
France
Tel: (+33) 5 64 31 08 50
Website: www.argolight.com
Support: customer@argolight.com

Note for readers

The experimental data shown in this documentation are informative and not contractual. They may be different from one system to another.



A word about waste management

Argolight policy is to offer robust and reliable products that last. In the event your product becomes useless to you, please contact us so we can pick it up and recycle it. Please do not throw away the slide with common waste. The composition of the glass requires specific recycling. Thank you.

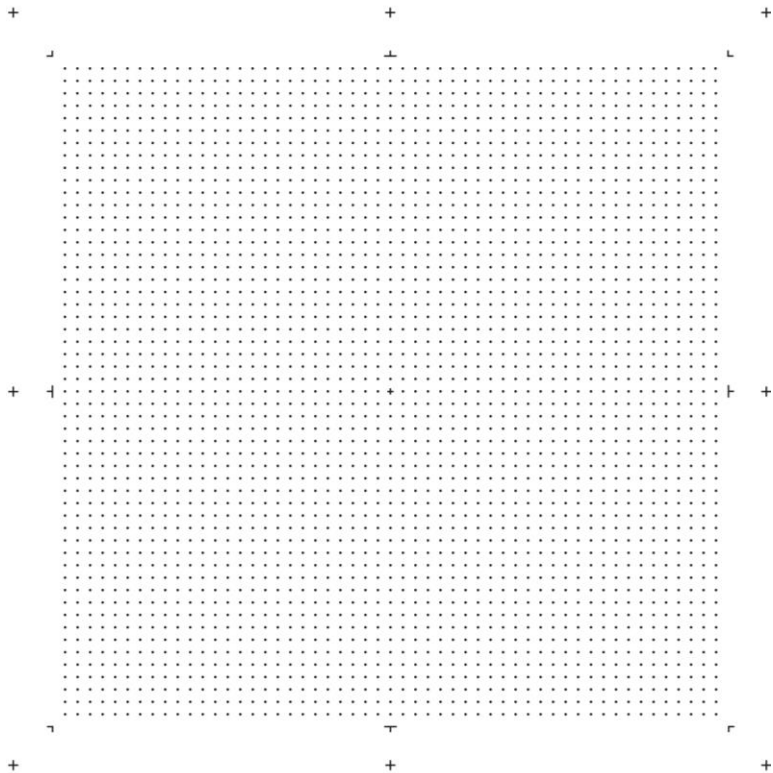

100 μ m

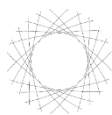
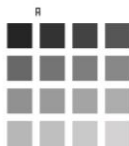

ARGOLIGHT
A Precision Company